



Peerless® *PUREFIRE*®

PF-110 Features and Standard Equipment

Performance:

- 95.0 Annual Fuel Utilization Efficiency (AFUE) AHRI Certified
- ENERGY STAR® Qualified
- Design Certified by SCAQMD for Low NOx Operation
- Modulating Burner with 4:1 Turndown Capability
- Factory Equipped for Outdoor Reset Operation
- Dual Temperature Settings for Central Heating and Domestic Hot Water
- Dual Flame Sensing for Reliable Ignition
- Suitable for Firing Natural or LP Gas

Construction:

- Designed, Constructed and Stamped in accordance with ASME Boiler & Pressure Vessel Code, Section IV
- Design certified for Zero Clearance to Combustible Construction
- Maximum Allowable Working Pressure: 160 PSI
- 304L Stainless Steel Heat Exchanger
- Sealed, Negative Pressure Cabinet
- Removable Jacket Panels
- Suitable for Floor or Wall Mounting
- Leveling Legs
- Factory Equipped with Boiler Service Switch
- 120 Volt Convenience Outlet

Exhaust/Air Intake Piping:

- Suitable for Sealed Combustion Operation
- CPVC Vent Adapter for PVC or CPVC Pipe
- Factory Supplied Vent & Air Inlet Terminations with Screens
- Vent Temperature Sensor

Safety Features:

- 30 PSIG ASME Safety Relief Valve (Loose)
- Pressure/Temperature Gauge (Loose)
- Integrated Connections for Low Water Cut Off or Flow Switch
- Manual Reset High Temperature Limit

Codes:

- Design Certified to ANSI Z21.13
- CSD-1 Compliant
- California Code Compliant
- Massachusetts Code Compliant

Control Features:

- Plain English Status Display
- Factory Equipped for Multiple Boiler Cascade Operation
- Flame Signal Logging Capability
- Freeze Protection
- DHW Tank Warm Hold
- Ramp Delay Step Modulation
- Outdoor Sensor Included
- System Type Presets
- Temperature Boost Function
- Warm Weather Shut Down
- Anti Cycling Logic
- Limited DHW Priority
- DHW Heat Economy Circulation
- Service Notification
- System Test for Manual Control of Firing Rate
- Fault History

Combustion System:

- State of the Art Metal Mesh Burner
- Dual Flame Sensing
- High Energy Spark Ignition

Condensate System:

- Built-in Condensate Trap with Neutralization
- Blocked Condensate Switch
- Highly Visible, Easy Access Condensate Collector

Warranty:

- One Year Parts and Labor Warranty
- 10 Year Limited Warranty

PEERLESS® PUREFIRE® HIGH EFFICIENCY STAINLESS STEEL BOILER

SERIES PEERLESS® PUREFIRE® BOILER RATINGS



Boiler	Input (MBH)		Heating Capacity (MBH)	Net Ratings (MBH)	AFUE (%)
	Min	Max			
PF-110	27.5	110	103	90	95.0

SERIES PEERLESS® PUREFIRE® DIMENSIONS

Dimensions (Inches)			Supply Return Connections	Gas Supply Connections	Air Intake & Vent Connection	Relief Valve Size NPT
"A"	"B"	"C"				
19-1/16"	7-5/8"	14-7/16"	1"	3/4"	3"	3/4"

SERIES PEERLESS® PUREFIRE® CAPACITIES

Gas Pressure Min/Max (Inch WC)	Total Water Capacity (Gallons)	Minimum Water Flow Rate (40°FΔT)		Total Combined Length of Air Intake & Vent (Feet)	Shipping Weight (Lbs)
		Flow Rate (GPM)	Pressure Drop (Feet)		
3.5 13.5	0.89	5.1	3.74	200	108

SERIES PEERLESS® PUREFIRE® ELECTRICAL RATINGS

Supply Voltage (-15%, +10%)	Frequency (±1.2 hz)	Blower		Gas Valve		Pumps		Max Total Service Current to Boiler
		Voltage (VAC)	Current (Amps)	Voltage (VAC)	Current (Amps)	Voltage (VAC)	Max. Current (Amps)	
120 VAC	60 hz	120	0.78	120	0.09	120	2.28	3.15

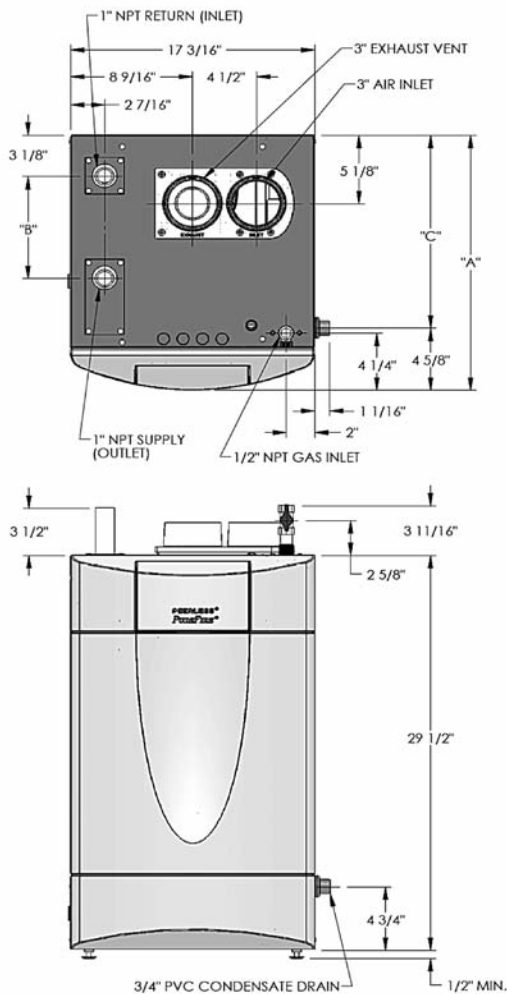

Optional Equipment:

- PFA-1 Interface Adapter
 - Alarm Contacts
 - Analog Input
 - Modbus Communications
- 3" Concentric PVC Vent Termination
- 3" Stainless Steel Vent Termination
- Wall Mounting Bracket
- Floor Mounted Steel Stand
- Domestic Water Tank Temperature Sensor
- System Sensor for Multiple Boiler Operation
- Primary-Secondary Piping Kit
- Boiler Circulator
- 50 PSI Safety Relief Valve
- 100 PSI Safety Relief Valve
- 150 PSI Safety Relief Valve
- PC Software
 - Status
 - Fault History
- Probe-Type Low Water Cutoff
- Expansion Tank
- High Performance Air Vent



PF8118 R2 (12/14)
Printed in U.S.A.