

# USER'S INFORMATION MANUAL

## **SERIES PBC™** **COMBINATION GAS BOILERS**

**TO THE INSTALLER:** *This manual is the property of the owner and must be affixed near the boiler for future reference.*

**TO THE OWNER:** *This boiler should be inspected annually by a Qualified Service Agency.*

### **⚠ WARNING**

If the information in this manual is not followed exactly, a fire or explosion may result causing property damage, personal injury or death.

- Do not store or use gasoline or other flammable vapors and liquids in the vicinity of this or any other appliance.
- **WHAT TO DO IF YOU SMELL GAS**
  - Do not try to light any appliance.
  - Do not touch any electrical switch; do not use any phone in your building.
  - Immediately call your gas supplier from a neighbor's phone. Follow the gas supplier's instructions.
  - If you cannot reach your gas supplier, call the fire department.
- Installation and service must be performed by a qualified installer, service agency or the gas supplier.

### **⚠ AVERTISSEMENT**

À défaut de suivre les instructions à la lettre, un incendie ou une explosion risque de causer des dommages matériels, des blessures ou des pertes de vie.

- Ne pas entreposer ni utiliser d'essence ou ni d'autres vapeurs ou liquides inflammables à proximité de cet appareil ou de tout autre appareil.
- **QUOI FAIRE S'IL Y A ODEUR DE GAZ**
  - Ne pas tenter d'allumer d'appareils.
  - Ne toucher aucun interrupteur électrique. Ne pas utiliser de téléphones dans le bâtiment ou il y a des odeurs.
  - Contacter immédiatement votre fournisseur de gaz depuis un bâtiment voisin. Suivre les instructions du fournisseur.
  - S'il est impossible de joindre le fournisseur de gaz, contacter le service des incendies.
- L'installation et l'entretien seront assurés par un installateur ou un service d'entretien qualifié, ou par le fournisseur de gaz.

### TO BE COMPLETED BY THE INSTALLER

Service Agency \_\_\_\_\_ Phone No. \_\_\_\_\_

Address \_\_\_\_\_

Boiler Model No. \_\_\_\_\_ Serial No. \_\_\_\_\_ Date of Installation: \_\_\_\_\_



PeerlessBoilers.com

**PB HEAT, LLC**

131 S. CHURCH ST • BALLY, PA 19503

PBC8023 R1 (02/24-2.5C)  
Printed in U.S.A.

©2024 PB Heat, LLC. All rights reserved.

## **WARNING**

### **Product Safety Information Refractory Ceramic Fiber Product**

This appliance contains materials made from refractory ceramic fibers (RCF). Airborne RCF, when inhaled, have been classified by the International Agency for Research on Cancer (IARC), as a possible carcinogen to humans. After the RCF materials have been exposed to temperatures above 1800°F (980°C), they can change into crystalline silica, which has been classified by the IARC as carcinogenic to humans. If particles become airborne during service or repair, inhalation of these particles may be hazardous to your health.

#### **Avoid Breathing Fiber Particulates and Dust**

Suppliers of RCF recommend the following precautions be taken when handling these materials:

#### **Precautionary Measures:**

**Provide adequate ventilation.**

**Wear a NIOSH/MSHA approved respirator.**

**Wear long sleeved, loose fitting clothing and gloves to prevent skin contact.**

**Wear eye goggles.**

**Minimize airborne dust prior to handling and removal by water misting the material and avoiding unnecessary disturbance of materials.**

**Wash work clothes separately from others. Rinse washer thoroughly after use.**

**Discard RCF materials by sealing in an airtight plastic bag.**

#### **First Aid Procedures:**

**Inhalation: If breathing difficulty or irritation occurs, move to a location with fresh clean air. Seek immediate medical attention if symptoms persist.**

**Skin Contact: Wash affected area gently with a mild soap and warm water. Seek immediate medical attention if irritation persists.**

**Eye Contact: Flush eyes with water for 15 minutes while holding eyelids apart. Do not rub eyes. Seek immediate medical attention if irritation persists.**

**Ingestion: Drink 1 to 2 glasses of water. Do not induce vomiting. Seek immediate medical attention.**

## **NOTICE**

This product burns gas to produce heat. The appliance must be properly installed, operated, and maintained to avoid exposure to appreciable levels of carbon monoxide and the installer is required to confirm that at least one carbon monoxide alarm is installed in the living space before the appliance is put into operation. It is important for the carbon monoxide alarms to be installed, maintained, and replaced following the alarm manufacturer's instructions and applicable local codes.

Ce produit brûle des gaz pour produire de la chaleur. L'appareil requiert une installation, un fonctionnement et une maintenance adéquates afin d'éviter l'exposition à des niveaux appréciables de monoxyde de carbone; l'installateur est requis de confirmer qu'au moins une alarme de détection de monoxyde de carbone est installée dans l'espace de vie avant que l'appareil ne soit mis en service. Il importe que les alarmes détection de monoxyde de carbone soient installées, maintenues et remplacées selon les directives du manufacturier et les codes locaux applicables.

## Basic Operation

### **WARNING**

Service on this boiler should be undertaken only by trained and skilled personnel from a qualified service agency.

### **CAUTION**

Should overheating occur or the gas supply fail to shut off, do not turn off or disconnect the electrical supply to the pump. Instead, shut off the gas supply at a location external to the appliance.

En cas de surchauffe ou si l'alimentation ne se coupe pas, ne pas éteindre manuellement ni couper l'alimentation électrique de la pompe. Couper plutôt l'alimentation en combustible à l'extérieur de l'appareil

Do not use this boiler if any part has been under water. Immediately call a qualified service agency to inspect the boiler and to replace any part of the control system and any gas control which has been under water.

- A. General:** This appliance is a sealed combustion, condensing water boiler and is equipped with controls for proper operation. All controls must be maintained in proper working order. Contact a qualified service agency to provide annual maintenance as specified in the Installation, Operation and Maintenance Manual.
- B.** The following diagram shows the safety controls and device locations on the appliance. If any one of these controls or devices are activated, contact a qualified service person immediately. **Do not try to correct the problem without contacting a qualified service person.**
- 1. Primary Safety Control:** The primary safety control monitors all limit controls and will prevent the appliance from operating if a limit has been exceeded. This device also monitors blower speed and temperature to assure safe operation of the appliance.
  - 2. High Vent Temperature Limit:** This device interrupts appliance operation if the vent temperature exceeds the maximum allowable temperature of the vent material. The control display module will display "Loc 16" if this device is activated.
  - 3. High Temperature Limit:** This device automatically interrupts boiler operation if the supply water temperature exceeds 190°degrees Fahrenheit. The primary safety control will not allow the unit to restart until the reset button is depressed on the display module. The control will display "Err 105" if the device is activated.
  - 4. Flame Sensor:** The flame sensor monitors the flame and communicates with the primary safety control to interrupt the gas flow to the appliance if no flame is present. The primary safety control will lock out if the flame sensor malfunctions producing a false flame signal. The control will display "Loc 1", "Loc 20", "Loc 21", "Loc 22," or "Err 114" if this device is activated.
  - 5. Safety Relief Valve:** This valve protects the boiler from excessive pressure. This device can discharge a large amount of hot water and should be piped to discharge near the floor and away from contact with people. The discharge should be piped near a floor drain if possible.
  - 6. Gas Valve:** This valve interrupts the gas flow if no power is present from the primary safety control.
  - 7. Vent Pressure/Blocked Condensate Switch:** This device automatically interrupts boiler operation if there is a blockage in the exhaust vent or condensate drainage line. The control will display "Err 163" if this device is activated.
- C.** Instructions for operation and shutting down your boiler are shown on the Operating and Lighting Instructions Label posted on the back of the boiler cover. The instructions are also shown in Figure 4.
- D.** The sequence of operation is shown in Figure 5.

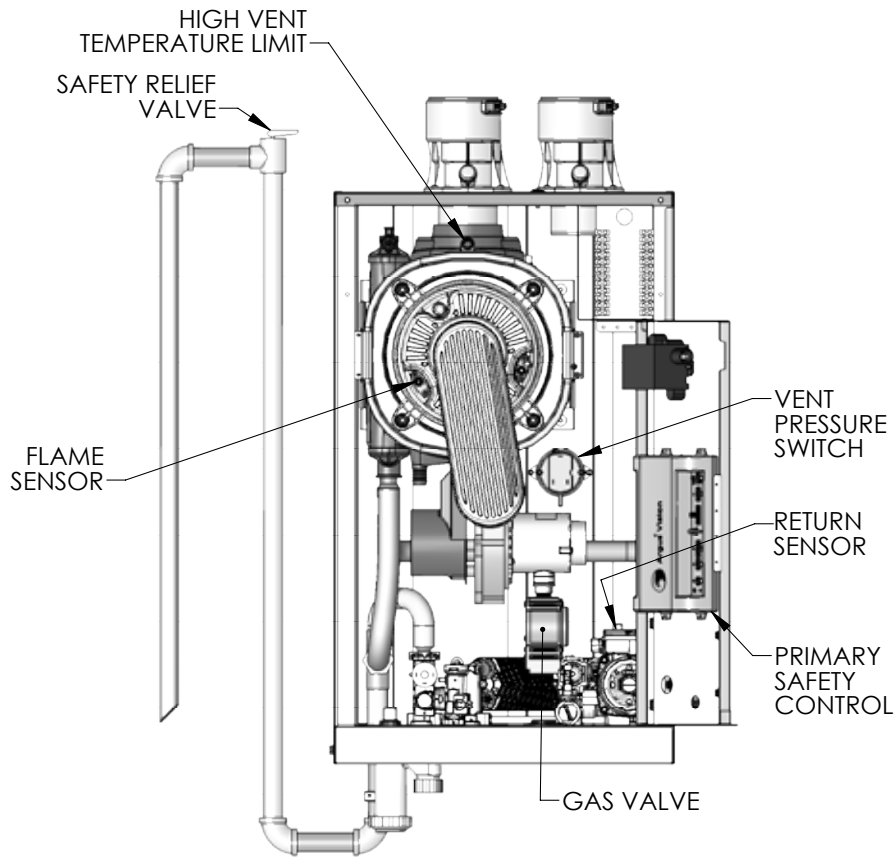

**Figure 1: Control & Safety Device Locations – PBC-34 through PBC-52 Models**

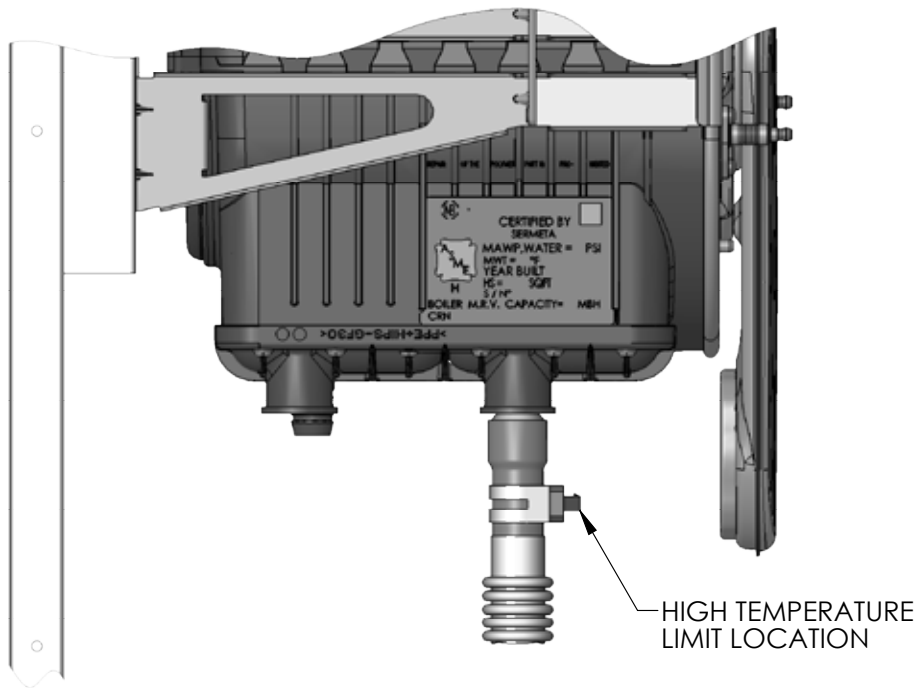

**Figure 2: High Temperature Limit Location- PBC-34 through PBC-52 Models**

## FOR YOUR SAFETY READ BEFORE OPERATING

**WARNING:** If you do not follow these instructions exactly, a fire or explosion may result causing property damage, personal injury, or loss of life.

- A. This appliance does not have a pilot. It is equipped with an ignition device which automatically lights the burner. Do not try to light the burner by hand.
- B. BEFORE OPERATING smell all around the appliance area for gas. Be sure to smell next to the floor because some gas is heavier than air and will settle on the floor.
- WHAT TO DO IF YOU DO SMELL GAS**
- Do not try to light any appliance.
  - Do not touch any electric switch; do not use any phone in your building.
  - Immediately call your gas supplier from a neighbor's phone. Follow the gas supplier's instructions.
  - If you cannot reach your gas supplier, call the fire department.
- C. Use only your hand to turn the gas control valve. Never use tools. If the handle will not turn by hand, don't try to repair it, call a qualified service technician. Force or attempted repair may result in a fire or explosion.
- D. Do not use this appliance if any part has been under water. Immediately call a qualified service technician to inspect the appliance and to replace any part of the control system and any gas control which has been under water.

## OPERATING INSTRUCTIONS

1. STOP! Read the safety information above.
2. Set the thermostat to lowest setting.
3. Turn off all electric power to the appliance.
4. This appliance is equipped with an ignition device which automatically lights the burner. Do not try to light the burner by hand.
5. Turn gas shutoff valve(s) clockwise ☺ to "OFF". Handle will be perpendicular to pipe, do not force.
6. Wait five (5) minutes to clear out any gas. Then smell for gas, including near the floor. If you smell gas, STOP! Follow "B" in the safety information above on this label. If you don't smell gas, go to the next step.
7. Turn gas shutoff valve(s) counterclockwise ☹ to "ON". Handle will be in line with the pipe.
8. Turn on all electric power to appliance.
9. Set thermostat to desired setting.
10. If the appliance will not operate, follow the instructions "To Turn Off Gas To Appliance" and call your service technician or gas supplier.

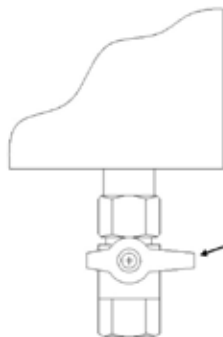

Gas Control Knob  
(shown in the  
"OFF" position)

## TO TURN OFF GAS TO APPLIANCE

1. Set the thermostat to lowest setting.
2. Turn off all electric power to the appliance if service is to be performed.
3. Turn the gas shutoff valve(s) clockwise ☺ to "OFF". Handle will be perpendicular to pipe, do not force.

(PBC)

9608 REV 0



Figure 3: Lighting and Operating Instructions

## POUR VOTRE SÉCURITÉ, LISEZ AVANT L'ALLUMAGE

**MISE EN GARDE:** Négliger de suivre ces instructions à la lettre pourrait provoquer un incendie ou une explosion causant des dégâts matériels, des blessures ou la mort.

- A. Cet appareil est muni d'un dispositif d'allumage automatique du brûleur. Ne tentez pas d'allumer le brûleur à la main.
- B. **AVANT DE METTRE EN MARCHÉ**, sentez autour de l'appareil pour détecter toute odeur de gaz. Etant donné que certains gaz sont plus lourds que l'air et se déposent sur le sol, s'assurer de bien sentir près du plancher.
- QUE FAIRE SI VOUS DÉTECTEZ UNE ODEUR DE GAZ
- Ne pas tenter d'allumer l'appareil
  - Ne toucher à aucun interrupteur électrique; n'utiliser aucun appareil téléphonique dans l'immeuble.
  - Contactez immédiatement votre fournisseur de gaz à partir du téléphone d'un voisin. Suivre les instructions données par votre fournisseur de gaz.
- C. S'il est impossible de rejoindre le fournisseur de gaz, appeler le service des incendies.
- D. N'utilisez que votre main pour appuyer ou tourner le bouton de commande du gaz. Ne jamais utiliser d'outils. S'il est impossible d'enfoncer ou de tourner le bouton à la main, ne tentez pas de le réparer. Appelez un technicien d'entretien qualifié. Une force excessive ou une tentative de réparation peut provoquer un incendie ou une explosion.
- D. N'utilisez pas cet appareil ni aucune de ses pièces si elles ont été immergées. Contactez immédiatement un technicien d'entretien qualifié pour inspecter l'appareil et remplacer toute pièce du système de régulation du débit gazeux et toute commande de gaz ayant été immergée.

## DIRECTIVES DE FONCTIONNEMENT

1. **ARRÊTEZ!** Lisez les consignes de sécurité plus haut sur cette étiquette.
2. Réglez le thermostat au niveau le plus bas.
3. Coupez toute l'alimentation électrique de l'appareil.
4. Cet appareil est muni d'un dispositif d'allumage automatique de brûleur. Ne tentez pas d'allumer les veilleuses à la main.
5. Tournez les boutons de commande dans le sens des aiguilles d'une montre  pour les mettre en position d'arrêt « OFF ».
6. Attendre cinq (5) minutes pour que tout le gaz présent puisse s'échapper. Sentir autour de l'appareil pour détecter toute odeur de gaz, incluant près du sol. Si vous sentez une odeur de gaz, **ARRÊTEZ!** Suivez les consignes de sécurité apparaissant en « B » plus haut sur cette étiquette. Si vous ne détectez aucune odeur de gaz, passez à l'étape suivante.
7. Tournez les boutons de commande dans le sens contraire des aiguilles d'une montre  pour le mettre en position de marche « ON ».
8. Remettez en marche toute l'alimentation électrique de l'appareil.
9. Réglez le thermostat au niveau désiré.
10. Si l'appareil ne se met pas en marche, suivez les instructions ci-dessous : « Couper l'alimentation en gaz de l'appareil » et appelez votre technicien d'entretien ou fournisseur de gaz.

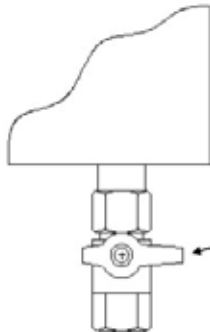

Bouton de Commande  
(illustré en Position  
d'arrêt «OFF»)

## COUPER L'ALIMENTATION EN GAZ DE L'APPAREIL

1. Réglez le thermostat au niveau le plus bas.
2. Si des travaux d'entretien doivent être effectués, coupez toute l'alimentation électrique de l'appareil.
3. Tournez les boutons de commande dans le sens des aiguilles d'une montre  pour les mettre en position d'arrêt « OFF ».

Figure 3a: Lighting and Operating Instructions

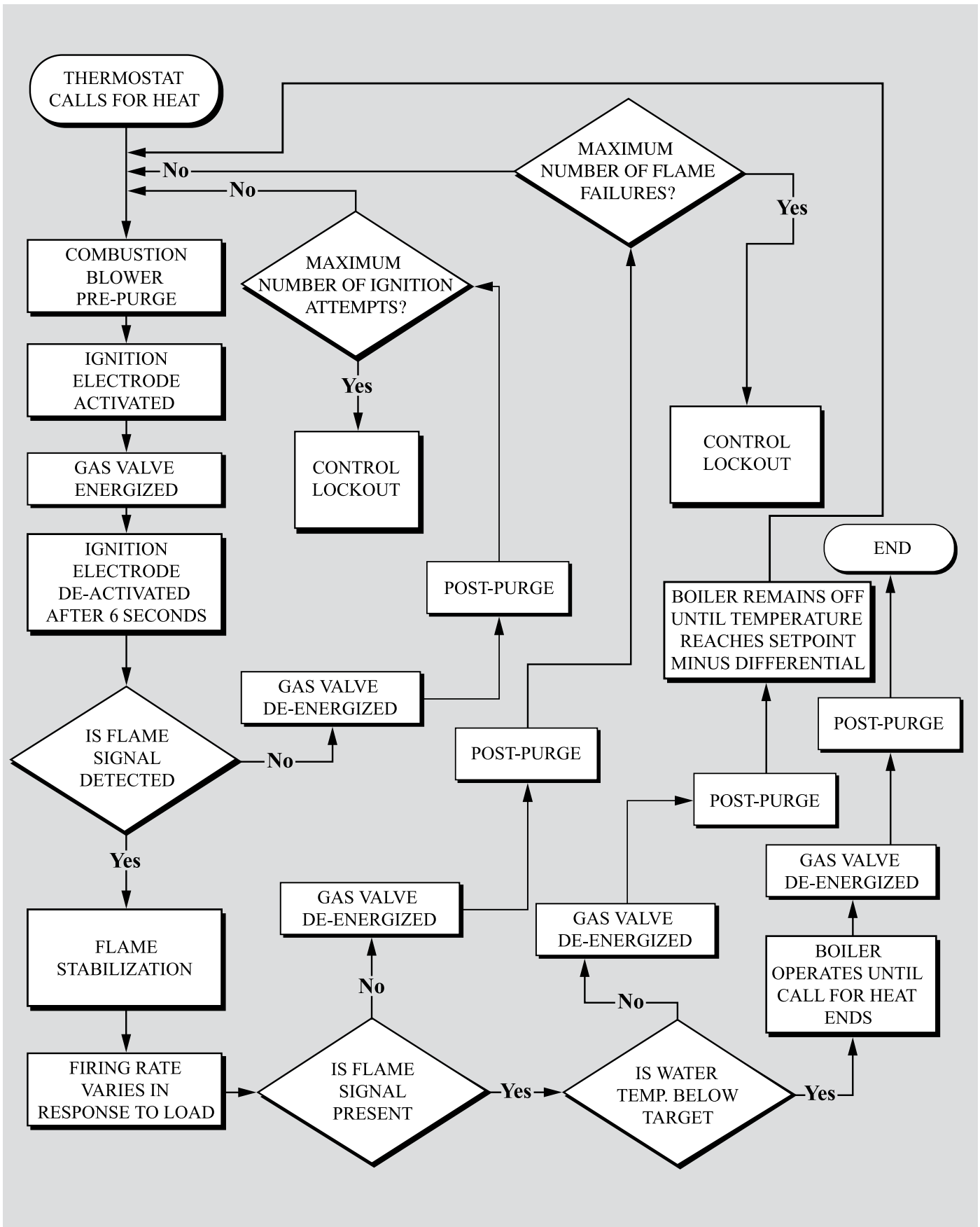

Figure 4: Sequence of Operation

---

## User Maintenance

---

### **WARNING**

**Service on this boiler should be undertaken only by trained and skilled personnel from a qualified service agency. Inspections should be performed at intervals specified in the Installation, Operation and Maintenance Manual and this User's Information Manual. Maintain manuals in a legible condition.**

**Keep boiler area clear and free of combustible materials, gasoline and other flammable vapors and liquids.**

**Do not place any obstructions in boiler room that will hinder flow of combustion and ventilation air.**

#### **A. General Housekeeping (Continuous)**

1. Keep the area around this appliance clear and free of combustible materials and obstructions.
2. Do not store or use flammable vapors or liquids, such as gasoline, in the vicinity of the boiler. This applies to any fossil fuel-fired appliance.
3. Do not store or use any sources of hydrocarbons in the vicinity of this appliance.
4. Do not store or use any sources of hydrocarbons in the vicinity of the inlet air termination. If the source of hydrocarbon contamination cannot be removed, the combustion air must be re-piped to a different location.
5. Sources of hydrocarbons include bleaches, detergents, cleaning solvents, chlorinated waxes or cleaners, chlorine based swimming pool chemicals, rock salt or other chloride based ice melt solutions, water softener salt, refrigerants, paint or varnish removers, fabric softeners, hydrochloric acid or muratic acid, cements, glues and adhesives.

#### **B. Inspect Venting / Air Inlet System (Monthly)**

1. Inspect the vent pipe and assure that it is continuous with no separations, obstructions, sags, discoloration, depressions or deformation. Vent pipe must be supported at minimum 4 foot (122 cm) intervals and secured with adhesive specifically formulated for the material used.

### **WARNING**

**Failure to inspect the venting system and, if problems are found, to notify a qualified service technician, may result in boiler exhaust entering the structure and causing severe personal injury or death from carbon monoxide poisoning and oxygen depletion.**

2. Air inlet piping must be continuous from the air inlet termination to the boiler with no separations, obstructions or sags. Air inlet piping must be supported at minimum 4 foot (122 cm) intervals and secured with adhesive specifically formulated for the material used.
3. Inspect around the vent and air inlet terminations outside the home for obstructions. Keep area clear of snow and debris. Inspect also for any gaps at the wall penetration(s) which could allow vented gasses to reenter the home.
4. Notify a qualified service contractor if any problems are found with the venting or air intake systems and be sure that the problems are corrected.

#### **C. Inspect Pressure Relief Valve (Monthly)**

1. Inspect the pressure relief valve outlet for signs of leakage.
2. Notify a qualified service contractor immediately if there are signs of leakage. (If the problem persists, it may be the result of a malfunctioning expansion tank or improper system design).



#### D. Inspect Condensate Drain System (Monthly)

1. With the boiler in operation with a call from the thermostat, check that condensate is flowing in the condensate tubing. Check for any blockage or restriction in the condensate drain lines.
2. Check the condensate drain piping for visible water leaks.
3. Check the level of condensate neutralization media (where used) in the front condensate collector.
4. Notify a qualified service contractor immediately if there are signs of leakage, blockage, or depleted neutralization media.

### **WARNING**

**Do not operate the boiler with the condensate drain line disconnected. If there is evidence of exhaust leakage from the condensate drain line, turn off the unit and contact a qualified service contractor. These conditions may result in boiler exhaust entering the structure and causing severe personal injury or death from carbon monoxide poisoning and oxygen depletion.**

#### E. Observe Boiler Operation (Monthly)

1. Initiate a call for heat from the system by turning up a room thermostat or draining hot water at a faucet (if an indirect water heater is used).
2. Observe the boiler start and listen for objectionable noises during the start-up.
3. Contact a qualified service person if objectionable sounds are observed.

#### F. Control Inspection and Maintenance (As Required by Control Manufacturer)

1. Safety Relief Valve. Conduct try lever test as outlined in manufacturer's instruction tag on the safety relief valve.
2. Low Water Cut-off (if used). Follow instructions provided by control manufacturer.

#### G. General Inspection and Maintenance (Annual)

Annual inspection and service is to be performed by a qualified service contractor as specified in the Installation, Operation and Maintenance Manual supplied to the installer with the boiler. If a copy of the original Installation, Operation and Maintenance Manual is not available a new copy is available at [PeerlessBoilers.com](http://PeerlessBoilers.com) or from your local PB Heat Representative.

#### H. Error Handling

##### 1. Lockout Errors

- a. When a lockout error occurs, the display will show "**Loc**" followed by a number code.
- b. Lockout codes require that the control be manually reset either by holding the center reset button on the display or by pressing the reset button on the main control board itself.
- c. Lockout errors should be investigated further by a qualified service technician to determine the cause.

##### 2. Blocking Errors

- a. When a blocking error occurs, the display will show "**Err**" followed by a number code.
- b. Blocking errors will automatically clear if the condition is corrected.
- c. These error messages and some suggested actions are listed in Table 10.2 of the IO&M.

##### 3. Warning Errors

- a. When a warning error occurs, the boiler display will show "**Atte**" followed by a number code.
- b. Warning errors will automatically clear once the condition is corrected and will not prevent the boiler from operating.
- c. **Warning 204** is for Outdoor Sensor not Connected. The Combi™ units will display this warning on start-up if the provided outdoor sensor is not connected.